

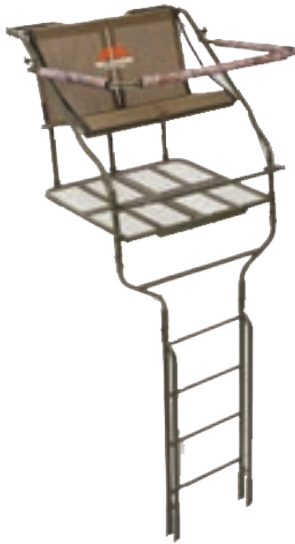

MILLENNIUM L-220-SL 18' DOUBLE LADDERSTAND INSTRUCTION MANUAL



Millennium L-220-SL
18' Double Ladderstand



PARTICIPATING MEMBER



Should you have any questions about the installation and/or use of this product, or any other Millennium product(s) do not hesitate to call one of our customer service representatives at (601) 932-5832 or visit us online at millenniumstands.com. Our service representatives will answer any questions you may have about any of the complete line of Millennium products.

ATTENTION! ATTENTION! ATTENTION!
If you do not have a full-body fall arrest harness system which meets or exceeds industry standards recognized by the TMA, contact Millennium Outdoors, LLC at 601-932-5832 or info@millenniumstands.com and we will furnish you one free of charge. If you do not intend to strictly follow these instructions, please return this Millennium Outdoors, LLC product, or any Millennium Outdoors, LLC product(s) to Millennium Outdoors, LLC for a full, no questions asked refund.

ATTENTION

YOU MUST READ ALL WRITTEN INSTRUCTIONS AND WATCH THIS SAFETY VIDEO BEFORE USING!

WATCH THIS SAFETY VIDEO BEFORE USING!

Scan →

or Visit → www.standsafety.com/m3

Scan the QR code with your smart phone, tablet or similar device.

OR

Type the website address into your web browser to view an important safety video before using this product.

LADDER STAND SAFETY

WARNING! This product carries strict weight limitations. Do not use this product if you exceed this total weight limitation. Please note this weight limit includes the user and equipment. Failure to follow these instructions may result in serious injury or death!

Model Number: L-110-SL Ladderstand
Maximum Weight Capacity - 300 pounds (136kg) (User and Equipment)

Thank you for your purchase of this quality Millennium product! To ensure your personal safety, please take a moment to carefully read this product Instruction Manual in its entirety before attempting to set-up, install and/or otherwise use this Millennium product. Failure to do so could result in serious personal injury or death! This Millennium product has been designed, engineered and manufactured to provide you with years of trouble free service.

WARNING! You must use the full-body fall arrest harness which meets or exceeds industry standards recognized by the TMA (Treestand Manufacturer's Association) and has been provided with this Millennium product(s) or an aftermarket full-body fall arrest harness which meets or exceeds industry standards recognized by the TMA when installing, removing or using this Millennium product(s). Failure to follow these instructions may result in serious injury or death!



Your full-body fall arrest harness included with your new Millennium treestand has a service life of three (3) years past its date of manufacture. This date of manufacture can be found on the sewn on label of each component of the fall arrest system. Replace this harness if the service life has expired. Should you experience a fall while wearing your full body fall arrest harness return it to the manufacturer for free replacement. You must read the full-body fall arrest harness Instruction Manual in its entirety prior to attempting to use this Millennium product(s) in any manner.

PLEASE READ THIS MANUAL IN ITS ENTIRETY PRIOR TO USING THIS PRODUCT!

PLEASE READ THIS MANUAL IN ITS ENTIRETY PRIOR TO USING THIS PRODUCT!



ATTENTION!!

WHEN YOU SEE A "WARNING!" BE SURE TO HEED THE MESSAGE! THE INFORMATION CONTAINED IN THESE MESSAGES CAN SAVE YOUR LIFE!!



WARNING! Falls from a treestand can occur anytime after leaving the ground. These falls result in either serious injury or death! For your personal safety, please take a moment to carefully read this product instruction manual in its entirety before attempting to assemble, set-up, install and/or otherwise use this Millennium product. At least annually, review the contents of this instruction manual and watch the safety information included in the Quick Response (QR) Code(s) which accompanies this Millennium product(s). Additionally, keep these instructions for the entire duration that you own this product(s). Failure to follow these instructions may result in serious injury or death!



WARNING! The safe use and operation of this product is the sole responsibility of the user. It is also the sole responsibility of the owner to provide any person(s) who borrow or purchase this product with these instructions. Failure to follow these instructions may result in serious injury or death! Additionally, failure to follow these instructions may subject you to personal liability penalties as determined by the U.S. Judicial system.



WARNING! Prior to each hunt, make sure that you have a signaling device (e.g., mobile phone, cell phone, radio, whistle, signal flare, Personal Locator Device [PLD], etc.) in your possession and on your person in an operable condition. This device must be within easy access should you experience the need to contact emergency assistance. Failure to follow these instructions may result in serious injury or death!



WARNING! Failure to read and strictly comply with the instructions contained in this Instruction Manual may result in serious injury or death!

PLEASE NOTE THAT "WARNING!" statements have been placed throughout this Instruction Manual. These statements point out important safety information and instructions, which, if not followed, could endanger the personal safety and/or property of the operator. It is imperative that the operator of this product, or any other Millennium product(s) read and understand all the instructions and warnings contained in this Instruction Manual prior to attempting to use this product(s), or any other Millennium product(s). Failure to comply with these instructions and/or warnings may result in serious injury or death! When you see a "WARNING!" statement - BE SURE TO HEED THE MESSAGE!



WARNING! Thoroughly inspect this or any other Millennium product(s) prior to each use for signs of wear, damage, rot, corrosion, deterioration and/or any other type of defect. DO NOT expose this product to extended exposure to direct sunlight, excessive heat and/or freezing temperatures. Do not use this or any other Millennium product(s) if they show evidence of wear, rot, corrosion, cracks, deterioration and/or any other type(s) of defect(s). Failure to follow these instructions may result in serious injury or death!



WARNING! Do not remove, modify and/or omit any portion or otherwise mechanically modify this Millennium product(s) or its assemblies in any manner. Modification, misuse and/or part substitution shall immediately void your factory warranty and may result in serious injury or death! If you suspect that a part(s) is missing and/or defective, immediately contact Millennium at (601) 932-5832 for replacement of missing or defective parts. Never modify your stand in any way by making repairs, or altering, adding or attaching anything to it except if explicitly authorized in writing by Millennium. ALWAYS USE GENUINE FACTORY AUTHORIZED MILLENNIUM REPLACEMENT PARTS. USE OF ANY REPLACEMENT PARTS OTHER THAN GENUINE MILLENNIUM PARTS VOIDS YOUR WARRANTY AND MAY RESULT IN SERIOUS INJURY OR DEATH!



WARNING! This Millennium product(s) is designed for adult use only. No one under the age of 16 shall attempt to use this or any other Millennium® product(s) without direct adult supervision. Failure to follow these instructions may result in serious injury or death!



WARNING! Prior to attempting to use this or any other Millennium product(s) you must take the time and become familiar with its assembly, setup, installation and removal. You must practice installing, setting-up, using and removing this product(s) at ground-level prior to attempting to use it at heights above ground-level. Once you have become thoroughly knowledgeable and comfortable with this Millennium product(s) set-up, installation, use and removal at ground-level, only then are you ready to use it at heights above ground-level. Failure to follow these instructions may result in serious injury and death!



WARNING! When hunting from a treestand, falls can occur any time after leaving the ground causing injury or death. Always wear your full-body fall arrest system (which meets or exceeds industry standards recognized by the TMA), comprising a full-body harness, tether, tree belt, linesman belt and Suspension Relief Device at all times after leaving the ground. You must stay connected at all times after leaving the ground. Single safety belts and chest harnesses are no longer allowed and shall never be used as they put the user at serious risk of injury or death. If you are not wearing your full-body fall arrest harness that is properly attached to the tree that is protecting you from a fall, do not leave the ground. Failure to follow these instructions may result in serious injury or death!



WARNING! Never rely on a tree branch for support while climbing. Failure to follow these instructions may result in serious injury or death!



WARNING! You must always inform someone of your hunting location, where the treestand will be located and the expected duration of the hunt. Failure to follow these instructions may result in serious injury or death!















WARNING! Inspect all safety devices each time before each use. DO NOT use these devices if it (they) shows signs of wear, damage (from freezing, excessive heat, etc.), deterioration or vandalism. Factors such as tree growth, vandals, weather and animals may affect the performance of an unattended tree stand. Do not store these devices outdoors when not in use. Failure to follow these instructions may result in serious injury or death!



WARNING! The length of the full-body fall arrest tether must be minimized at all times. It shall be adjusted so that it is above the head with no slack (snug) in the sitting position and you shall have the minimum amount of slack possible when climbing. Failure to follow these instructions may result in serious injury or death!

ATTENTION!!

WHEN YOU SEE A "WARNING!" BE SURE TO HEED THE MESSAGE! THE INFORMATION CONTAINED IN THESE MESSAGES CAN SAVE YOUR LIFE!!

-  WARNING! Do not remove, modify, and/or omit any portion or otherwise mechanically modify this Millennium product(s) or its assemblies in any manner. Modification, misuse, and/or part substitution shall immediately void your factory warranty and may result in serious injury or death! If you suspect that a part(s) is missing and/or defective, immediately contact Millennium at (601) 932-5832 for replacement of missing or defective parts. Never modify your stand in any way by making repairs, or altering, adding or attaching anything to it except if explicitly authorized in writing by Millennium. Always use genuine factory authorized Millennium replacement parts. Use of any replacement parts other than genuine Millennium parts voids your warranty and may result in serious injury or death!
-  WARNING! Prior to each hunt, make sure that you have a signaling device (e.g., mobile phone, radio, whistle, signal flare or Personal Locator Device (PLD)) in your possession and in an operable condition. This device must be within easy access should you experience the need to contact emergency assistance. Failure to follow these instructions may result in serious injury or death!
-  WARNING! ALWAYS inspect/check ALL expiration dates/tags on all straps and the full-body fall arrest harness and its components prior to each use. You must replace ALL straps and suspension seats EVERY year. Never use any strap(s) or full-body fall arrest harness that has expired and/or is showing any signs of damage and/or wear. Failure to follow these instructions may result in serious injury and death!
-  WARNING! Make certain all chains, cable straps, etc. are tightened per this Instruction Manual prior to use. All treestand contact points must be in contact with the tree before you step onto the stand. The correct adjustment and tightening of attachment hardware is critical to the stable installation of this treestand. Additionally, you MUST be wearing your Fall Arrest System (FAS) which includes a full-body fall arrest harness, tree belt, lanyard/tether, suspension relief device and climbing belt/linesmen belt (as applicable) in accordance with the Instructions contained in this Instruction Manual. Failure to follow these instructions may result in serious injury or death!
-  WARNING! This product(s) is designed for adult use only. No one under the age of 16 shall attempt to use this or any other product(s) without direct adult supervision. Failure to follow these instructions may result in serious injury or death!
-  WARNING! Prior to attempting to use this or any other Millennium product(s) you must take a moment and become familiar with its assembly, setup and installation. You must practice installing, setting-up and using this product(s) at ground-level prior to attempting to use it at heights above ground-level. Once you have become thoroughly knowledgeable and comfortable with this Millennium product(s) setup, installation and use at ground-level, you are now ready to use it at heights above ground-level. Failure to follow these instructions may result in serious injury or death!
-  WARNING! Several Millennium treestands are equipped with a footrest, armrests and/or shooting rail. Neither the footrest, armrests nor the shooting rail have been designed to support the users weight. Under no circumstances shall you place any more than fifteen (15) pounds of weight on these structures. Doing so will put the user in serious risk of injury or death. Failure to follow these instructions may result in serious injury or death!
-  WARNING! You must wear a Fall Arrest System (FAS) comprising of a full-body fall arrest harness, tree belt, lanyard, suspension relief device and climbing belt/lineman's belt (as applicable) at all times after leaving the ground. You must stay connected at all times after leaving the ground while using fixed position treestands. Single safety belts and chest harnesses are no longer allowed and shall never be used. If you are not wearing a full-body fall arrest harness that is properly attached to the tree to protect you from a fall, do not leave the ground nor attempt to enter your treestand. Failure to follow these instructions may result in serious injury or death!
-  WARNING! DO NOT modify, fix/repair, alter, bend, cut, weld, or heat the treestand in any way. Also, do not attach anything to your treestand without explicit authorized and written instructions from the manufacturer. Failure to follow these instructions will void your warranty and may result in serious injury or death!
-  WARNING! Never attempt to climb up or down with a weapon and/or gear in your possession. ALWAYS unload your weapon and pull it up to hunting height using a tether or pull up rope. ALWAYS lower your unloaded weapon down to the ground prior (when raising or lowering firearms, the chamber must be open and the barrel pointing toward the ground) to attempting to climb up or climb down. Use this same method when raising or lowering all other gear. Failure to follow these instructions may result in serious injury or death!
-  WARNING! Prior to each use thoroughly inspect the treestand (and its components) and all safety devices each time before use for signs of wear, rot, corrosion, cracks, deterioration and/or any other type of defect. Make certain that your treestand is tight and secure prior to use. Protect this product from extended exposure to direct sunlight, excessive heat or freezing temperatures by storing inside when not in use. Do not use this or any other product(s) if it shows evidence of wear, rot, corrosion, cracks, deterioration and/or any other type of defect. Failure to follow these instructions may result in serious injury or death!
-  WARNING! DO NOT attempt to make adjustments to this product while in the treestand. All adjustments must be made with the entire treestand on the ground. Failure to follow these instructions may result in serious injury or death!



ATTENTION!!



WHEN YOU SEE A "WARNING!" BE SURE TO HEED THE MESSAGE! THE INFORMATION CONTAINED IN THESE MESSAGES CAN SAVE YOUR LIFE!!



WARNING! DO NOT use this or any other Millennium products(s) if you have a history of heart problems, back problems, impaired vision, joints that lock-up, spinal fusions, equilibrium problems, high blood pressure, are not well-rested and/or any other physical impairment that may limit your ability to use and/or operate this product(s) in the safe manner outlined in this Instruction Manual. Additionally, do not use this or any other Millennium product(s) if you are currently taking medication (including prescription) and/or using and/or consuming any substance, including alcohol, that may limit your ability to use this Millennium product(s) as outlined and described in the Instruction Manual. Never use a treestand when feeling ill, nauseous or dizzy. Failure to follow these instructions may result in serious injury or death!



WARNING! DO NOT leave your Millennium product(s) installed for more than two weeks (14 days). Any number of factors can jeopardize its installation and integrity. These include, but are not limited to, weather or other environmental factors that can negatively affect its performance. Animals can also cause damage to your Millennium product(s) that can negatively affect its performance and your safety. Additionally, factors such as tree growth can stress and damage supporting straps, chains and/or buckles. Failure to follow these instructions may result in serious injury or death!



WARNING! ALWAYS inspect the treestand and all safety devices prior to each use. DO NOT use product if it shows signs of wear, damage, deterioration, or vandalism. Factors such as tree growth, vandals, weather and animals may affect the performance of an unattended treestand. Failure to follow these instructions may result in serious injury or death!



WARNING! Strict weight limitations have been set for each product to ensure your personal safety. Note the weight limitations of your stand and that this weight limit includes the user(s) and equipment. NEVER EXCEED THESE WEIGHT LIMITATIONS! Failure to follow these instructions may result in serious injury or death!



WARNING! DO NOT jump or bounce on the treestand platform and/or the seat to engage the stand to the tree. Failure to follow these instructions may result in serious injury or death!



WARNING! DO NOT attempt to use this or any other Millennium product(s) when ice, snow, and/or freezing rain has deposited or formed on any portion of the tree or stand you intend to climb. Do not attempt to use this or any other Millennium product(s) when thunderstorms are threatening and/or present within five (5) miles. Do not attempt to use this or any other product(s) when any other adverse weather condition presents itself. These include, but are not limited to, weather conditions which have the potential for producing winds, lightning, rain, snow, sleet and/or any other atmospheric condition which may limit the user's ability to operate this Millennium product(s) in a safe manner as described in this Instruction Manual. Should inclement weather conditions arise during your use of this Millennium product(s), return to the ground immediately. Failure to follow these instructions may result in serious injury or death!



WARNING! BEFORE each use, make sure all nuts and bolts are secure. CHECK all hardware and webbing prior to every use to make sure that no damage has occurred to hardware and that webbing (as applicable) is not cut or frayed. Keep webbing from coming into contact with any sharp edges. DO NOT USE THIS PRODUCT IF ANY DAMAGE IS SUSPECTED. Failure to follow these instructions may result in serious injury or death!



WARNING! REPLACE any damaged or worn part with original parts. Replace attachment belts every three years and when not in use store in a dry, cool, safe place away from sunlight. Never store a treestand or any of its components outdoors when not in use. To purchase parts contact Millennium at (601) 932-5832. Failure to follow these instructions may result in serious injury or death!



WARNING! Always wear the appropriate foot wear when using a treestand. A good non-slip safety boot is important for your safety. Be especially careful that boot laces do not get hooked on the treestand (or any of its components) or climbing aids (tuck shoelaces into boot before climbing). Failure to follow these instructions may result in serious injury or death!



WARNING! DO NOT use this product, or attempt to use a treestand, on a dead, leaning, diseased, loose barked tree (bark that flakes or falls off), irregular shaped trees, or utility poles. DO NOT use this product on any tree that does not allow for a level standing platform. Failure to follow these instructions may result in serious injury or death!



WARNING! NEVER hunt out of a treestand at heights at which you are not completely comfortable. Depending upon the tree and hunting conditions, choose the minimum hunting height that allows for safe, effective hunting. Failure to follow these instructions may result in serious injury or death!



WARNING! DO NOT use this, or any other product(s) to climb utility poles, telephone poles, structural columns or any other man-made structures. Never use this or any other product(s) around power generation (e.g., transformers, generators, substations, etc.) and/or power transmission equipment. Never use a treestand on a dead, leaning, diseased or loose barked tree. NEVER USE A TREE BRANCH, OR ANY PORTION OF A TREE, TO SUPPORT ANY PORTION OF YOUR WEIGHT OR AS A HAND HOLD. Failure to follow these instructions may result in serious injury or death!

ATTENTION!!



WHEN YOU SEE A "WARNING!" BE SURE TO HEED THE MESSAGE! THE INFORMATION CONTAINED IN THESE MESSAGES CAN SAVE YOUR LIFE!!



WARNING! DO NOT stand on the treestand seat. Failure to follow these instructions may result in serious injury or death!



WARNING! These Millennium product(s) were designed for installation on trees with a minimum diameter of nine (9) inches at tree-stand installation height (i.e., seat height). DO NOT use your Millennium product(s) on trees with trunk diameters that do not meet this minimum diameter requirement. Failure to follow these instructions may result in serious injury or death!



WARNING! A minimum of three (3) adults is required to install and/or remove a ladderstand. Failure to follow these instructions may result in serious injury or death!



WARNING! The stabilizer straps and stabilization devices must be attached and tightened before attempting to climb to the seating/standing platforms. Failure to follow these instructions may result in serious injury or death!



WARNING! When installing a ladderstand, always apply weight on the first rung to set the ladder firmly into the ground. Failure to follow these instructions may result in serious injury or death!



WARNING! Check the ground under ladderstands and climbing systems to make sure it is firm and level. Sloping ground or uneven surfaces (e.g., one side on a rock) can cause the ladder to tilt or shift off the tree as you climb. Failure to follow these instructions may result in serious injury or death!



WARNING! Always maintain three-point contact when climbing up/down a tree when using climbing aids and/or ladderstands. Proper three-point contact means having either two feet with one hand or one foot with two hands on the step portion of the climbing aids at all times when climbing up or down. Failure to follow these instructions may result in serious injury or death!



WARNING! Always lean forward as you climb and attach your full-body fall arrest harness tree belt to the tree trunk before securing the platform to the tree and stepping onto the platform. Failure to follow these instructions may result in serious injury or death!

Should you have any questions about the assembly, installation or use of this product, or any other product, please do not hesitate to call one of our customer service representatives at (601) 932-5832 and they will answer all questions you may have about any of the complete line of Millennium products.

OPTIONAL ACCESSORIES AND REPLACEMENT PARTS

Any number of innovative accessories are available and sold separately to compliment your new climbing system. Only genuine authorized accessories shall be used with your climbing/treestand system. Genuine replacement parts are also available online or via telephone. Should you require parts or service, or if you just have a question about this, or any other product(s), simply give one of our customer service representatives a call (601) 932-5832 or visit us online at millenniumstands.com.

FULL-BODY FALL ARREST HARNESS SYSTEM (FAS)



WARNING! Failure to read and strictly comply with the instructions contained here may result in serious injury or death!

Read the full-body fall arrest harness section carefully and follow all of the instructions! Your full-body fall arrest harness and its component (i.e., lanyard/tether, tree belt, climbing belt (lineman 's belt as applicable), suspension relief device) is designed for a maximum capacity (user and equipment) of 300 pounds (136 kg). Additionally, your full-body fall arrest harness (and its components) must be replaced after three (3) years of service! Please contact Millennium for full -body fall arrest harness replacement procedure should you experience a fall or shall it exceed the three (3) year service period.



WARNING! Prior to attempting to use this or any other product(s) you must take a moment and become familiar with its assembly, setup and installation. You must practice installing, setting-up and using your full-body fall arrest harness and its components (i.e., lanyard/tether, tree belt, suspension relief device, climbing belt/lineman's belt [as applicable]) at ground level prior to attempting to use it at heights above ground-level. Once you have become thoroughly knowledgeable and comfortable with this product(s) setup, installation and use at ground-level, you are now ready to use it at heights above ground-level. Failure to follow these instructions may result in serious injury or death!



WARNING! You must wear a Fall Arrest System (FAS) comprising of a full-body fall arrest harness, lanyard/tether, tree belt, suspension relief device, and climbing belt/lineman's belt (as applicable) at all times after leaving the ground. You must stay connected at all times after leaving the ground while using fixed position treestands. Single safety belts and chest harnesses are no longer preferred and shall never be used. If you are not wearing a full-body fall arrest harness (that is connected to the tree) that is protecting you from a fall, do not leave the ground. Failure to follow these instructions may result in serious injury or death!

and shall never be used. If you are not wearing a full-body fall arrest harness (that is connected to the tree) that is protecting you from a fall, do not leave the ground. Failure to follow these instructions may result in serious injury or death!



WARNING! You must practice putting the full-body fall arrest harness on, adjusting and using your full-body fall arrest harness and its components (i.e., lanyard/tether, tree belt, suspension relief device, climbing belt/lineman's belt [as applicable]) at ground-level in the presence of a responsible adult to experience the feeling of hanging suspended before using in a hunting environment. This experience will ensure you remain calm and collected should you experience a fall while hunting. Failure to follow these instructions may result in serious injury or death!



WARNING! The length of the full-body fall arrest harness lanyard/tether must be kept to a minimum at all times during use. It shall be adjusted so that it is above the head with no slack (snug) in the sitting position and you shall have the minimum amount of slack possible when climbing. Never let the tether strap get under your chin or around your neck. Failure to follow these instructions may result in serious injury or death!



WARNING! Should you experience a fall there is time to make a correct decision on what action needs to take place. It is important to remember: **DO NOT PANIC!** Failure to follow this warning may result in serious injury or death!



WARNING! If you have a limiting physical and/or health condition that precludes and/or renders you incapable of self-recovery and/or a suitable escape plan is not available, **DO NOT** hunt from heights above ground-level. Failure to follow these instructions may result in serious injury or death!



WARNING! Falls from a treestand can occur anytime after leaving the ground. These falls could result in either serious injury or death! For your personal safety, please take a moment to carefully read this product Instruction Manual in its entirety before attempting to assemble, set-up, install and/or otherwise use this Millennium product. At least annually, review the contents of this Instruction Manual and watch the treestand safety: it's up to you DVD. Additionally, keep these instructions for the entire duration that you own this product(s). Failure to follow these instructions may result in serious injury or death!



WARNING! The safe use and operation of this product is the sole responsibility of the user. It is also the sole responsibility of the owner to provide any person(s) who borrow or purchase this product from them with these complete instructions. Failure to follow these instructions may result in serious injury or death! Additionally, failure to follow these instructions may subject you to personal liability penalties as determined by the U.S. Judicial system.



WARNING! Prior to each hunt, make sure that you have a signaling device (e.g., mobile phone, radio, whistle, signal flare, Personal Locator Device [PLD], etc.) in your possession and on your person in an operable condition. This device must be within easy access should you experience the need to contact emergency assistance. Failure to follow these instructions may result in serious injury or death!



WARNING! Practice the use of your Millennium full-body fall arrest harness and Suspension Relief Device (SRD) at ground-level in the presence of a responsible adult to experience the feeling of hanging suspended before using in a hunting environment. Failure to follow these instructions may result in serious injury or death!



WARNING! NEVER allow the full-body fall arrest harness lanyard/tether to get under your chin or around your neck. This poses a choking hazard that can lead to serious injury or death. Failure to follow these instructions may result in serious injury or death!















WARNING! If your hunting location is unknown by anyone and communication efforts are unsuccessful, you must have a personal plan for self-recovery/escape should you experience a fall. Prolonged suspension in a full-body fall arrest harness can be fatal. It is important to exercise the legs by pushing against the tree or doing other forms of continuous leg exercises to avoid blood pooling while being suspended. Varying degrees of physical fitness may require different plans for self-recovery/escape the effects of prolonged suspension. Have a personal plan and practice it in the presence of a responsible adult before leaving the ground. No one escape/rescue plan will work for every hunter, on every tree, in every circumstance. Only you can determine the best self-recovery/escape plan for your hunting situation before leaving the ground. There is time to make a correct decision on what action to take if a fall occurs while wearing a full-body fall arrest harness. It is important to remember, **DO NOT PANIC.** Remain calm and implement your practiced rescue, relief and recovery plan. Hunt from the ground when a self-recovery /escape ability is absent. Failure to follow these instructions may result in serious injury or death!

FULL-BODY FALL ARREST HARNESS SYSTEM WARNINGS



WARNING! Failure to read and strictly comply with the instructions contained here may result in serious injury or death!

Read the full-body fall arrest harness section carefully and follow all of the instructions! Your full-body fall arrest harness and its component (i.e., lanyard/tether, tree belt, climbing belt (lineman's belt as applicable), suspension relief device) is designed for a maximum capacity (user and equipment) of 300 pounds (136 kg). Additionally, your full-body fall arrest harness (and its components) must be replaced after three (3) years of service! Please contact Millennium for our full-body fall arrest harness replacement procedure should you experience a fall or shall it exceed the three (3) year service period.

-  **WARNING!** Prior to attempting to use this or any other product(s) you must take a moment and become familiar with its assembly, setup and installation. You must practice installing, setting-up and using your full-body fall arrest harness and its components (i.e., lanyard/tether, tree belt, suspension relief device, climbing belt/lineman's belt [as applicable]) at ground level prior to attempting to use it at heights above ground-level. Once you have become thoroughly knowledgeable and comfortable with this product(s) setup, installation and use at ground-level, you are now ready to use it at heights above ground-level. Failure to follow these instructions may result in serious injury or death!
-  **WARNING!** You must wear a Fall Arrest System (FAS) comprising of a full-body fall arrest harness, lanyard/tether, tree belt, suspension relief device, and climbing belt/lineman's belt (as applicable) at all times after leaving the ground. You must stay connected at all times after leaving the ground while using fixed position treestands. Single safety belts and chest harnesses are no longer preferred and shall never be used. If you are not wearing a full-body fall arrest harness (that is connected to the tree) that is protecting you from a fall, do not leave the ground. Failure to follow these instructions may result in serious injury or death!
-  **WARNING!** You must practice putting the full-body fall arrest harness on, adjusting and using your full-body fall arrest harness and its components (i.e., lanyard/tether, tree belt, suspension relief device, climbing belt/lineman's belt [as applicable]) at ground-level in the presence of a responsible adult to experience the feeling of hanging suspended before using in a hunting environment. This experience will ensure you remain calm and collected should you experience a fall while hunting. Failure to follow these instructions may result in serious injury or death!
-  **WARNING!** The length of the full-body fall arrest harness lanyard/tether must be kept to a minimum at all times during use. It shall be adjusted so that it is above the head with no slack (snug) in the sitting position and you shall have the minimum amount of slack possible when climbing. Never let the tether strap get under your chin or around your neck. Failure to follow these instructions may result in serious injury or death!
-  **WARNING!** Should you experience a fall there is time to make a correct decision on what action needs to take place. It is important to remember: **DO NOT PANIC!** Failure to follow this warning may result in serious injury or death!
-  **WARNING!** If you have a limiting physical and/or health condition that precludes and/or renders you incapable of self-recovery and/or a suitable escape plan is not available, **DO NOT** hunt from heights above ground-level. Failure to follow these instructions may result in serious injury or death!
-  **WARNING!** Falls from a treestand can occur anytime after leaving the ground. These falls could result in either serious injury or death! For your personal safety, please take a moment to carefully read this product Instruction Manual in its entirety before attempting to assemble, set-up, install and/or Otherwise use this Millennium product. At least annually, review the contents of this Instruction Manual and watch the treestand safety: it's up to you DVD. Additionally, keep these instructions for the entire duration that you own this product(s). Failure to follow these instructions may result in serious Injury or death!
-  **WARNING!** The safe use and operation of this product is the sole responsibility of the user. It is also the sole responsibility of the owner to provide any person(s) who borrow or purchase this product from them with these complete instructions. Failure to follow these instructions may result in serious injury or death! Additionally, failure to follow these instructions may subject you to personal liability penalties as determined by the U.S. Judicial system.
-  **WARNING!** Prior to each hunt, make sure that you have a signaling device (e.g., mobile phone, radio, whistle, signal flare, Personal Locator Device [PLD], etc.) in your possession and on your person in an operable condition. This device must be within easy access should you experience the need to contact emergency assistance. Failure to follow these instructions may result in serious injury or death!
-  **WARNING!** Practice the use of your Millennium full-body fall arrest harness and Suspension Relief Device (SRD) at ground-level in the presence of a responsible adult to experience the feeling of hanging suspended before using in a hunting environment. Failure to follow these instructions may result in serious injury or death!
-  **WARNING!** NEVER allow the full-body fall arrest harness lanyard/tether to get under your chin or around your neck. This poses a choking hazard that can lead to serious injury or death. Failure to follow these instructions may result in serious injury or death!
-  **WARNING!** If your hunting location is unknown by anyone and communication efforts are unsuccessful, you must have a personal plan for self-recovery/escape should you experience a fall. Prolonged suspension in a full-body fall arrest harness can be fatal. It is important to exercise the legs by pushing against the tree or doing other forms of continuous leg exercises to avoid blood pooling while being suspended. Varying degrees of physical fitness may require different plans for self-recovery/escape the effects of prolonged suspension. Have a personal plan and practice it in the presence of a responsible adult before leaving the ground. No one escape/rescue plan will work for every hunter, on every tree, in every circumstance. Only you can determine the best self-recovery/escape plan for your hunting situation before leaving the ground. There is time to make a correct decision on what action to take if a fall occurs while wearing a full-body fall arrest harness. It is important to remember, **DO NOT PANIC.** Remain calm and implement your practiced rescue, relief and recovery plan. Hunt from the ground when a self-recovery /escape ability is absent. Failure to follow these instructions may result in serious injury or death!

FULL-BODY FALL ARREST HARNESS SYSTEM INSTRUCTIONS

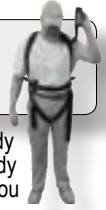

WARNING! Read these Millennium full-body fall arrest harness instructions carefully and follow all the instructions! Your new full-body fall arrest harness is designed for a maximum capacity (user and equipment) of 300 pounds (136 kg). Additionally, your new full-body fall arrest harness must be replaced after three (3) years of service! Replace your full-body fall arrest harness immediately should you experience a fall while wearing it. Failure to follow these instructions may result in serious injury or death!



WARNING! Falls from treestands can occur without warning. Product failures, falling asleep, misuse, vandalism, animal damage, etc. can lead to falls. However unlikely, falls from heights to the ground below can be eliminated by using the full-body fall arrest harness system which was provided with this product. You must use this (or aftermarket equivalent) full-body fall arrest harness system, as outlined herein, at all times when using your Millennium Outdoors, LLC treestand product. Failure to follow these instructions will result in serious injury or death!



WARNING! Use the Millennium full-body fall arrest harness provided with this product or a harness which meets or exceeds industry standards recognized by the TMA. NOTE: You must store your full-body fall arrest harness out of direct sunlight and out of any other harsh environmental condition(s) that may adversely affect its performance. Failure to follow these instructions may result in serious injury or death!



WARNING! It may be necessary to purchase an aftermarket full-body fall arrest harness which meets or exceeds industry standards recognized by the TMA should the Millennium full-body fall arrest harness provided with this product(s) not be sufficiently large enough. Remember: never exceed the weight capacity of this product(s). Failure to follow these instructions may result in serious injury or death!



Figure 1
Full-Body Fall Arrest Harness (Front and Rear Views)



Figure 2
Step Into Leg Loops



Figure 3
Slip Right Arm Into
Right Shoulder Strap



Figure 4
Full-Body Fall Arrest
Harness On Loosely



Figure 5
Wrap Waist Belt
Around Waist

STEP 1. Identify the main parts of the full-body fall arrest harness as depicted in Figure 1. Hold the full-body fall arrest harness by the tether loop insuring the harness is upright and leg straps are hanging down as depicted in Figure 2. Straighten any straps which may have become twisted. With the leg loops hanging at the bottom, step into each leg loop while holding the shoulder straps as shown in Figure 2.

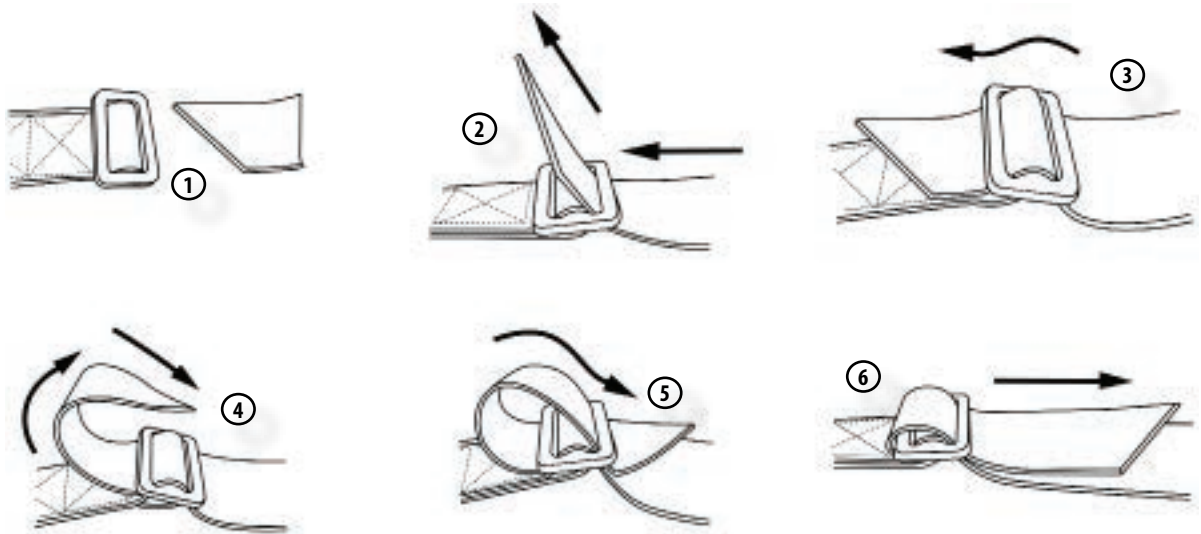

Figure 6
Thread Waist Buckle



Figure 7
Tighten Leg Loops/Positioned
Snugly in Groin Area



Figure 8
Full-Body Fall Arrest Harness Donned
Correctly (Front and Rear Views)

STEP 2: With both left and right legs in the leg loops, slip your right arm through the right shoulder strap as shown in Figure 3. With your right arm in the right shoulder strap, repeat this Step for your left arm. The full-body fall arrest harness shall now be hanging loosely about your torso as shown in Figure 4.

STEP 3: Locate the waist belt and waist belt buckle as shown in Figure 1. Wrap the waist belt around your waist as shown in Figure 5. Thread the buckle as shown in Figure 6. Extreme care must be taken to thread the waist buckle as depicted in Figure 6. Tighten the waist buckle until the waist belt is snug. DO NOT overtighten as this may become very uncomfortable and potentially cut-off your circulation.



WARNING! DO NOT overtighten the leg loops as this may cut-off circulation and cause an unsafe condition. Failure to follow these instructions may result in serious injury or death!

STEP 4: With the waist belt comfortably snug, locate the two (2) leg loop buckles as shown in Figure 1. Adjust both leg loop buckles so the leg loops are positioned snugly in the groin area as shown in Figure 7. Tighten the leg loops so they are snug, however, not overly tight. Overtightening of the leg loops will restrict circulation to the legs and cause an unsafe condition.



WARNING! DO NOT overtighten the waist belt as this may cut-off circulation and cause an unsafe condition. Failure to follow these instructions may result in serious injury or death!

STEP 5: With the leg loops tightened to a comfortable fit and the waist belt adjusted snugly, your full-body fall arrest harness shall now be donned as shown in Figure 8.

FULL-BODY FALL ARREST HARNESS SYSTEM INSTRUCTIONS (TREE BELT)



Figure 9
Insert Tree Belt Through Full-Body Fall Arrest Harness Tether Loop

STEP 1: Once you have reached your desired height, insert the tree belt (refer to Figure 1 for identification) through the loop of the full-body fall arrest harness tether loop as shown in Figure 9. Wrap the tree belt around the tree at a height that allows just enough slack for you to sit comfortably in your stand (as shown in Figure 10). NOTE: Keeping the full-body fall arrest harness tether as short as possible limits the distance you will travel in the unlikely event you should experience a fall.



Figure 10
Wrap Tree Belt Around Tree Trunk

STEP 2: Secure the tree belt by inserting the tag (free-end) end through the slot in the buckle closest to opposite end of the tree belt, then cross over the sliding mechanism and back down through opposite slot. Pull on tree belt to secure and test to make sure sliding mechanism engages, creating secure tree belt placement. Refer to Figure 11 for proper tree belt buckle threading. YOU MUST thread the tree belt buckle as shown in Figure 11. Failure to do so may result in failure of the tree belt.



WARNING! YOU MUST thread the tree belt buckle as shown in Figure 11. Failure to thread the buckle as shown will result in the belt failing to hold and separation from the tree trunk. Failure to follow these instructions may result in serious injury or death!

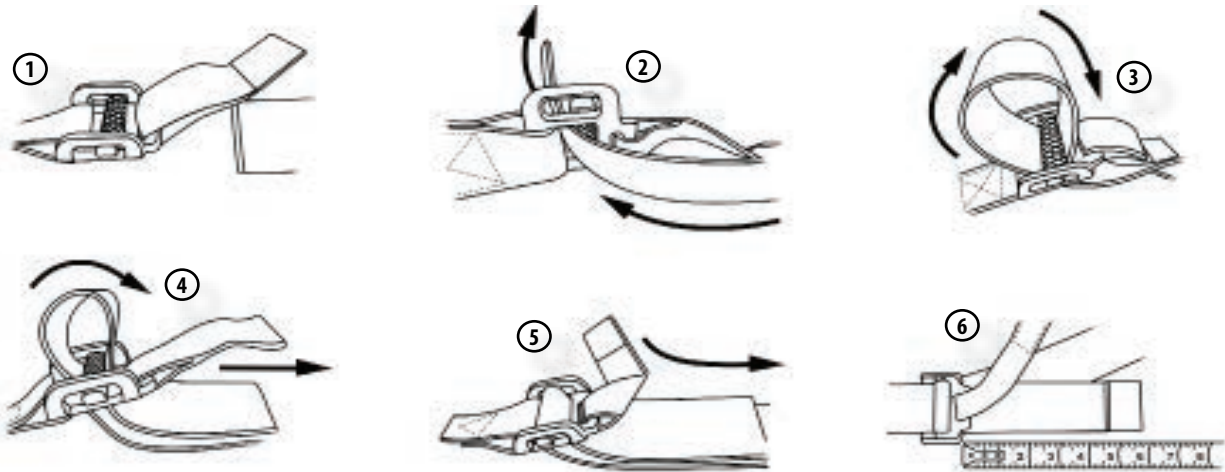

Figure 11
Threading Tree Belt Buckle

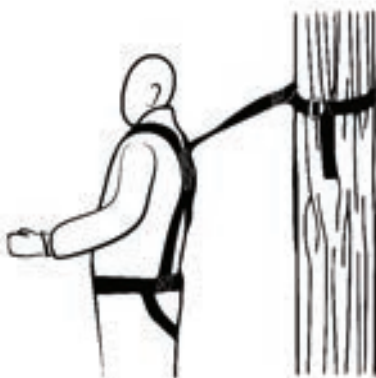

Figure 12
Full-Body Fall Arrest Harness Tether While Standing



Figure 13
Full-Body Fall Arrest Harness Tether While Seated

STEP 3: With the full-body fall arrest harness tree belt and tether installed as outlined previously, adjust the height of the tree belt so it is taut as shown in Figures 12 and 13. Please note, the tether length will vary depending on whether or not you are plan on standing or sitting during your use of this Millennium Outdoor product. You must keep the tether length as short as possible at all times to minimize the distance you might fall in the unlikely event you experience a fall while using this Millennium product.

PLEASE READ THIS MANUAL IN ITS ENTIRETY PRIOR TO USING THIS PRODUCT!

PLEASE READ THIS MANUAL IN ITS ENTIRETY PRIOR TO USING THIS PRODUCT!

FULL-BODY HARNESS SYSTEM INSTRUCTIONS (SUSPENSION RELIEF DEVICE)

No one plans to fall from their treestand, however, falls can and do occur without warning. It is important to know what to do in the unlikely event you experience a fall from an elevated hunting position. It is also very important you practice your escape plan at ground-level prior to entering an elevated hunting platform. There is time to make a correct decision on what action to take if a fall occurs while wearing a full-body fall arrest harness. It is important not to panic. Remain calm and implement your practiced rescue, relief and recovery plan.

A Suspension Relief Device, or SRD, has been provided with this Millennium product. It is provided to help relieve the pressure on your lower extremities in the unlikely event you experience a fall from an elevated hunting position.



WARNING! A suspension relief device must be on your person and readily accessible while using a full-body fall arrest harness. These devices will allow you to relieve the load on the lower extremities if suspended in a full-body fall arrest harness and help maintain circulation in the legs and mitigate (minimize) suspension trauma (blood pooling) or allow descent to the ground. Follow all instructions below regarding the provided SRD (Suspension Relief Device) Failure to follow full-body fall arrest harness instructions could result in not being able to return to the stand and being suspended in a full-body fall arrest harness after a fall. Failure to follow this warning may result in serious injury or death!

STEP 1: After a fall, take a moment to catch your breath and stay calm. Remain calm and do not panic.

STEP 2: Pull out the SRD strap located on the waist belt of your full-body fall arrest harness.

STEP 3: Adjust the SRD strap so you are able to step into the loop and then stand up, placing your weight in the standing loop and relieving the pressure on your lower extremities. The loop size can be adjusted by moving the buckle up or down (refer to Figure 14 for SRD operation).

STEP 4: If you are able to reach your ladder or climbing system, use it to get back into your secured treestand and then carefully climb down to ground-level. If you are not able to reach your stand, remain calm and continue to stand in the SRD loop and use your personal locating device or cell phone to call for help.

Important Note Regarding Self Extractors

Several optional products/systems are available that offer self-recovery or self-extraction from a fall when suspended in a full-body fall arrest harness. Some systems automatically descend the user while others allow user control. One of these products/systems can be considered for use as an additional safety precaution against prolonged suspension and suspension trauma. Be sure to follow the manufacturers' directions on the safe use of these products/systems.

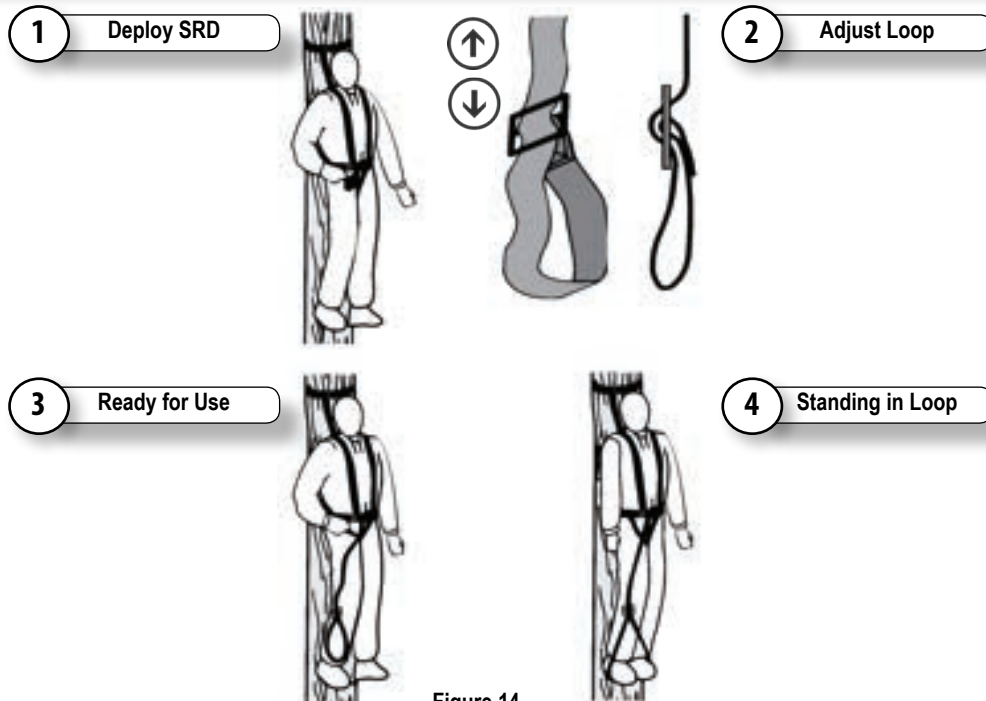

Figure 14
Suspension Relief Device (SRD) Operation

SAFE LINK 2 CLIMBING ROPE SYSTEM COMPONENTS

DO NOT WASH THIS PRODUCT IN A WASHING MACHINE!



A Safe Link 2 climbing rope system has been included with this product(s) for your use. Please note it is included for your optional use; its use is not mandatory. It is designed to compliment hang-on, fixed position, and ladderstands. It is designed to ensure you are safely connected at all times while ascending (climbing up) and descending (climbing down) trees. Your Safe Link 2 climbing rope system has several components:

1) climbing rope; 2) prusik hitch (six loops and prusik loop); and 3) carabiner as shown in Figure A. For safe operation, the prusik hitch MUST be configured as shown below in Figure A. If it is not, configured as such DO NOT USE, REMOVE FROM SERVICE!

The prusik hitch MUST:

1) Have six (6) loops; 2) Have secure knot; 3) Have 3" tail beyond knot end; and 4) Lock to the climbing rope when pulled on.

If not configured in this manner, and if it does not lock to the climbing rope--DO NOT USE!

Remove from service and call (601) 932-5832 for replacement instructions.

Model Number: Safe Link 2 Climbing Rope System

Maximum Weight Capacity: **300 pounds (136 kg)**
(One (1) User and Equipment)



- WARNING!** This Safe Link 2 is designed to accommodate ONE (1) climber (user/person) at a time. Under no circumstances shall two (2) persons be attached at the same time. Failure to follow these instructions may result in serious injury or death!
- WARNING!** The prusik hitch must be configured as shown in Figure A. If it is not, DO NOT use! Failure to follow these instructions will result in serious injury or death!
- WARNING!** This Safe Link 2 climbing rope system and its components has been designed to be used only as a safety device for hunting from elevated treestands. Any other use is prohibited (i.e., towing vehicles, hoisting, lifting, load restraint, etc.). Failure to follow these instructions may result in serious injury or death!
- WARNING!** You MUST read all the "Warnings!" in this Instruction Manual prior to attempting to use this product(s). Failure to follow these instructions may result in serious injury or death!
- WARNING!** DO NOT hold or grab the prusik hitch should you experience a fall. This may cause the prusik hitch to release its hold on the climbing rope, causing it to slip and you to fall further. Failure to follow these instructions may result in serious injury or death!

SAFE LINK 2 CLIMBING ROPE SYSTEM INSTALLATION



Figure B
Wrap Rope Around Tree Trunk



Figure C
Slip Knot End Through Loop



Figure D
Prusik Hitch on Loose End Side of Climbing Rope



Figure E
Carabiner Closed and Locked

STEP 1: Don (put on) your full-body fall arrest harness and lineman style belt which meets or exceeds industry standards recognized by TMA as outlined in its Instruction Manual.

STEP 2: Install/set-up your ladderstand, fixed position or hang-on treestand in strict accordance with its Instruction Manual and those provided with the full-body fall arrest harness Instruction Manual.

STEP 3: While using a lineman's belt per your full-body fall arrest harnesses Instruction Manual, climb to your hang-on or fixed position treestand. NOTE: The prusik hitch shall be snug on the climbing rope. Prior to use, check to ensure it is tight by sliding it a few feet along the climbing rope. If necessary, tighten the prusik hitch by pulling on the prusik loop to increase the tension of the prusik hitch on the climbing rope.

STEP 4: While at treestand installation height and while attached to the tree firmly with your linesmen belt, wrap the loop end of the climbing rope around the tree as shown in Figure B.

STEP 5: Slip the knot end of the climbing rope through the loop end of the climbing rope as shown in Figure C. Make certain the prusik hitch is threaded through the loop end.

STEP 6: Pull the climbing rope through the loop and allow its length to fall gently to the ground below. Make certain the prusik hitch is now positioned on the loose climbing rope side of the climbing rope as shown in Figure D.

STEP 7: To use, attach the carabiner to your full-body fall arrest tether loop making certain the carabiner is closed and the collar is locked as shown in Figure E. Make certain the knot at the end of the prusik hitch is tight and that it has at least 3" of "tail" as shown in Figure A.

SAFE LINK 2 SYSTEM USE/ASCENDING & DESCENDING (SINGLE USER)



Figure F
Slide Prusik Hitch Down Climbing Rope



Figure G
Keep Prusik Hitch Above Head At All Times



Figure H
Slide Prusik Hitch Up Climbing Rope as High as Possible



Figure I
Position Prusik Hitch as High as Possible

DESCENDING

STEP 1: When you are ready to descend the tree, **do not disconnect** your full-body fall arrest harness tether from the climbing rope. Climb down the tree, sliding the prusik hitch down as you go as shown in Figure F.

STEP 2: Move the prusik hitch down the climbing rope frequently as you descend. Make certain to keep the prusik hitch above your head at all times (as shown in Figure G) while climbing down to limit the distance you may fall in the unlikely event you should experience a fall while descending.

STEP 3: Once you are on the ground and disconnected from your Safe Link 2 climbing rope system, tie the knot end of the climbing rope around the bottom rung of the ladder. This allows you to easily slide the prusik hitch up as you climb (ascend). Remove as much slack from the climbing rope as possible, making it as tight as possible when tying it off. This practice allows the prusik hitch to slide easily up and down the climbing rope when ascending and descending.

ASCENDING

STEP 1: Connect your full-body fall arrest harness tether to the carabiner as outlined in STEP 7 above.

STEP 2: Slide the prusik hitch up the climbing rope as high as you can *comfortably* reach without over-reaching as shown in Figure H.

STEP 3: Begin climbing to your treestand while maintaining three points of contact on your climbing sticks, steps, or ladder. When you reach the prusik hitch height, slide it up the climbing rope a high as you can *comfortably* reach without over-reaching. Continue climbing and moving the prusik hitch up as you climb until you reach your desired climbing height.

STEP 4: Once in your treestand, slide the prusik hitch up as high as possible, thus limiting the distance you may fall in the unlikely event you should experience a fall while using this product(s) as shown in Figure I. NOTE: You must raise your prusik hitch as high a possible to limit the distance you may fall in the unlikely event you experience a fall.



WARNING! You must position your prusik hitch as high up the tree trunk as possible. This practice limits the distance you will fall in the unlikely event you experience a fall. Failure to follow these instructions may result in serious injury or death!

SAFE LINK 2 SYSTEM USE/ASCENDING & DESCENDING (TWO USERS)

NOTE: You MUST install your Safe Link 2 as described in the "SAFE LINK 2 CLIMBING ROPE SYSTEM INSTALLATION" section above. These instructions are provided to assist you in installing your Safe Link 2 climbing rope system safely.



WARNING! You must read and follow the installation instructions in the "SAFE LINK 2 CLIMBING ROPE SYSTEM INSTALLATION" section above. Failure to install the Safe Link 2 as outlined above may result in serious injury or death!

STEP 1: The first person to climb using the Safe Link 2, must attach his/her harness's tether to the top (upper/top carabiner) making sure the carabiner is closed and the locking collar is tightened securely as shown in Figure E.

STEP 2: The first climber will now ascend, gripping the prusik knot lightly, sliding it along the Safe Link 2 climbing rope. ALWAYS remove your hand from the prusik hitch once it has been moved into position. DO NOT hold the prusik hitch while climbing as this can cause the prusik hitch to fail to grab the climbing rope (and mitigating/stopping a fall) in the unlikely event you experience a fall.

Once the first climber reaches the treestand, he/she must connect to their full-body fall arrest harness tree belt.

NOTE: ONLY ONE (1) user may be attached to Safe Link 2 at any given time. Follow all manufacturer's instructions when attaching your tether and tree belt to the tree trunk. You must stay attached to Safe Link 2 until you have connected to the full-body fall arrest harness tree belt. Only disconnect from Safe Link 2 once you have attached to the full-body fall arrest harness tree belt which is secured around the tree trunk as outlined in the manufacturer's Instruction Manual.

STEP 5: Once the first climber has been secured to the tree and is safely in the treestand, the second climber can begin to climb. Attach your full-body fall arrest harness tether to the lower/bottom carabiner on the Safe Link 2 climbing rope.

STEP 6: You may now begin to ascend, gripping the prusik knot lightly, sliding it along the Safe Link 2 climbing rope. ALWAYS remove your hand from the prusik hitch once it has been moved into position. DO NOT hold the prusik hitch while climbing as this can cause the prusik hitch to fail to grab the climbing rope (and mitigating/stopping a fall) in the unlikely event you experience a fall. Once safely in the treestand, you may remain attached to the climbing rope for the duration of your hunt. Make certain your prusik hitch is slid up as high as possible, thus limiting the distance you may fall in the unlikely event you should experience a fall while using this product(s) as shown in Figure I.

NOTE: You must position your prusik hitch as high up the tree trunk as possible. This practice limits the distance you will fall in the unlikely event you experience a fall.



WARNING! You must position your prusik hitch as high up the tree trunk as possible. This practice limits the distance you will fall in the unlikely event you experience a fall. Failure to follow these instructions may result in serious injury or death!

NOTE: The second climber shall remain attached to Safe Link 2 climbing rope while in the treestand. Make certain the prusik hitch is as high up the tree trunk as possible. This practice limits the distance you will fall in the unlikely event you experience a fall.

STEP 7: To descend, the second climber (still attached to Safe Link 2) descends, gripping the prusik hitch lightly, sliding it down the Safe Link 2 climbing rope (shown in Figure F). ALWAYS remove your hand from the prusik knot once it is moved into position. DO NOT hold the prusik knot while climbing as it can cause this product to fail. Keep the prusik hitch above your head at all times. Once safely back on the ground, disconnect from the Safe Link 2 climbing rope.

STEP 8: The first climber (attached to the tree trunk via their full-body fall arrest harness tree belt) shall attach the first carabiner to their full-body fall arrest harness tether, making sure the carabiner is closed and the locking collar is tightened securely as shown in Figure E. Once attached to the Safe Link 2 carabiner, remove your tether from the tree belt.

STEP 9: Move the prusik hitch down the climbing rope frequently as you descend. Make certain to keep the prusik hitch above your head at all times (as shown in Figure G) while climbing down to limit the distance you may fall in the unlikely event you should experience a fall while descending.

SAFE LINK 2 CLIMBING ROPE SYSTEM REPLACEMENT

You must replace your Safe Link 2 if it has been subjected to severe shock loading (i.e., prevented/mitigated a fall), was exposed to any type of overloading (i.e., improper use or other), demonstrates any signs of wear (i.e., fraying, abrasion, nicking, stretching, etc.) has been subjected to inclement weather for more than two (2) weeks, has become stiff or hard, has been exposed to vandalism or animal damage (i.e., animal damage).

MILLENNIUM L-220-SL 18' DOUBLE LADDERSTAND ASSEMBLY



Some assembly is required prior to your use of your Millennium treestand. NOTE: ALL assembly shall be performed with the ladderstand components laying flat on the ground.

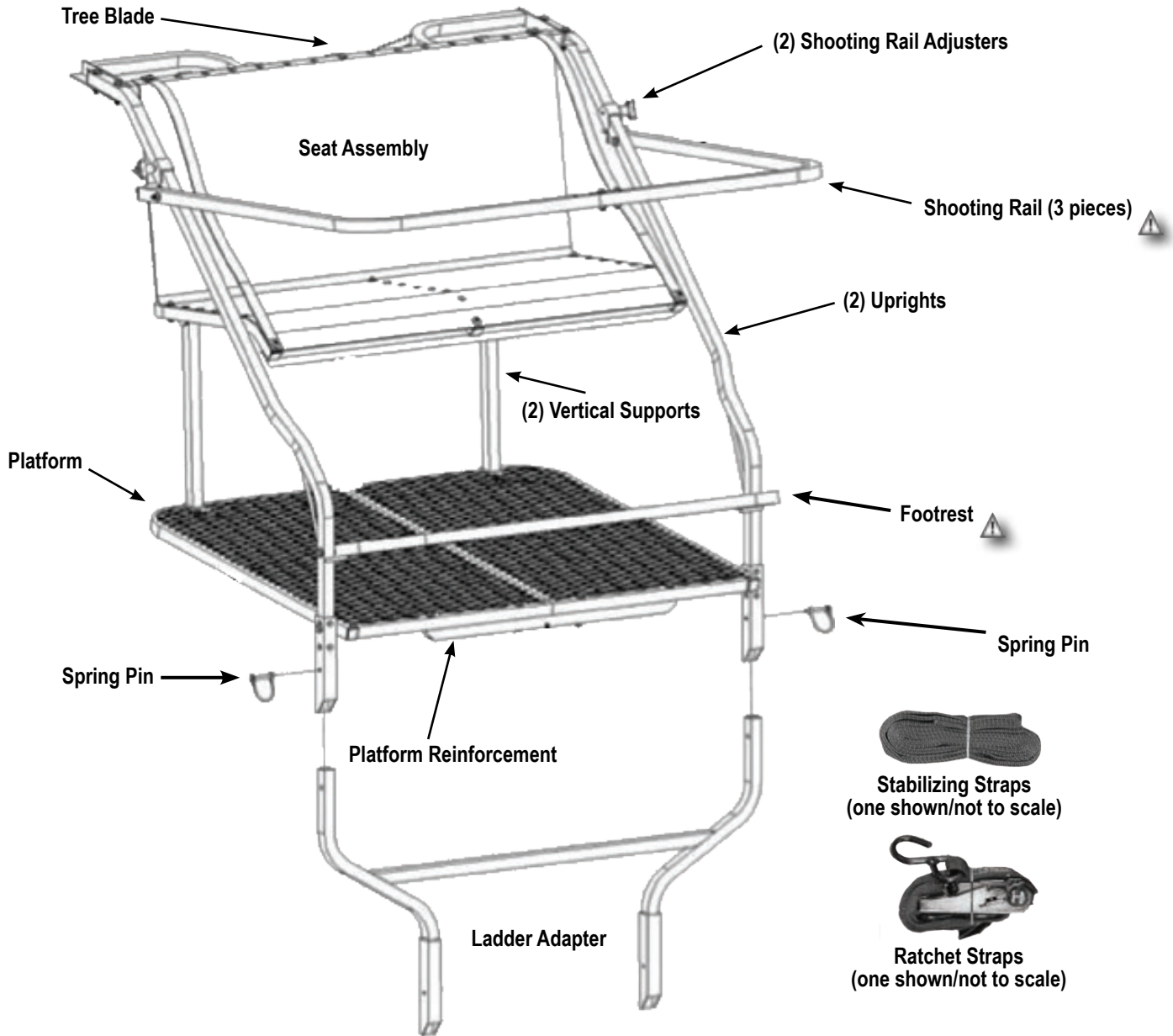

WARNING! DO NOT place more than fifteen (15) pounds (7 kg) of weight on the footrest or the shooting rail. Doing so will result in an unsafe condition. Failure to follow these instructions may result in serious injury or death!

Figure 15
Components of the L-220-SL 18' Double Ladderstand

PLEASE READ THIS MANUAL IN ITS ENTIRETY PRIOR TO USING THIS PRODUCT!

PLEASE READ THIS MANUAL IN ITS ENTIRETY PRIOR TO USING THIS PRODUCT!

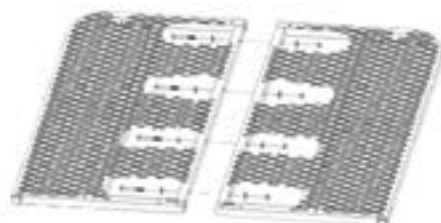

Figure 16
Bolt Platform Together

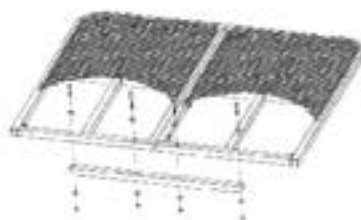

Figure 17
Install Platform Reinforcement Tube to Platform



Figure 18
Install Hinges to Seat Frame

STEP 1: Place the two (2) platform sections together as shown in Figure 16 and bolt together using four (4) 2 3/4" bolts, eight (8) washers, and four (4) locknuts. Make certain to place a washer under the head of each bolt and under each locknut. Tighten locknuts to 50 inch pounds.

STEP 2: Bolt the platform reinforcement tube to the bottom of the platform using two (2) 2 1/2" bolts, two (2) 2" bolts, eight (8) washers and four (4) locknuts as shown in Figure 17. Make certain to place a washer under the head of each bolt and under each locknut. Tighten locknuts to 50 inch pounds.

STEP 3: Bolt two (2) hinges to the seat frame with two (2) 1 3/4" bolts, two (2) washers, and two (2) locknuts as shown in Figure 18. Make certain to place a washer under each of the locknuts. From this point in the assembly, until the end, leave bolts loose until assembly is complete. This practice will help ensure the assembly goes together easily.



Figure 19
Install Shooting Rail Adjusters on Uprights



Figure 20
Install Tree Blade



Figure 21
Attach Platform to Uprights

STEP 4: Install the shooting rail adjusters on the uprights as shown in Figure 19 making certain the foot rest stop pegs on the lower end of the uprights are facing in as shown in Figure 19.

STEP 5: Install the tree blade onto the uprights using four (4) 1/4" x 1 3/4" bolts, eight (8) washers, and four (4) locknuts as shown in Figure 20. NOTE: The seat rivets must be facing upward.

STEP 6: Attach the platform to the uprights using two (2) 3" bolts, six (6) washers, and two (2) locknuts as shown in Figure 21. Make certain to install a washer under the bolt head, the nut, and between the platform and the uprights as shown in Figure 21.

STEP 7: Install the two (2) vertical supports. NOTE: All seat hinge discs point to the right side on the stand as shown in Figures 23 & 24. Use two (2) 2" bolts, eight (8) washers, and two (2) locknuts as shown in Figure 22. Connect the vertical supports to the tree blade before connecting to the seat hinges. Make certain to install washers under the head of each bolt, between the bracket, the vertical support, and under the locknuts as shown in Figure 22.



Figure 22
Install Vertical Supports

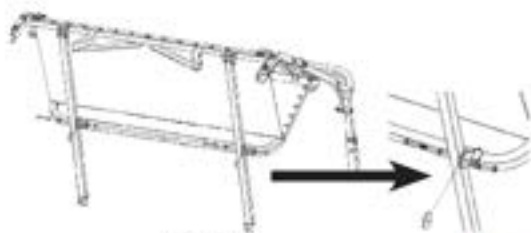

Figure 23
Connect Seat Hinges

STEP 8: Connect the two (2) seat hinges to the vertical supports using two (2) 2" bolts, four (4) washers, two (2) black Teflon washers, and two (2) locknuts as shown in Figure 23.

STEP 9: Bolt the vertical uprights and the rear platform support tube to the platform using four (4) 1 3/4" bolts, eight (8) washers, and four (4) locknuts as shown in Figure 24. Make certain to place a washer under the head of each bolt and under each locknut.

STEP 10: Assemble the two (2) sections of shooting rail using two (2) 1 1/2" bolts, four (4) washers, and two (2) locknuts as shown in Figure 25. Install the assembled shooting rail onto the uprights using two (2) 2 3/4" bolts, six (6) washers, and two (2) locknuts as shown in Figure 25. Make certain to place a washer under each bolt head, between the shooting rail and upright, and under each locknut as shown in Figure 25.

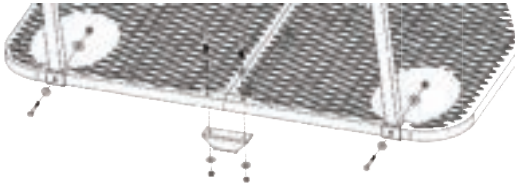

Figure 24
Install Vertical Supports
and Rear Platform Support Tube

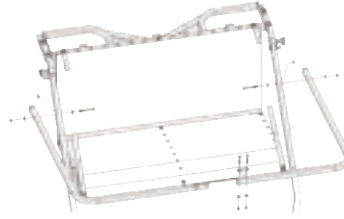

Figure 25
Install Shooting Rail



Figure 26
Install Footrest



Figure 27
Assemble Ladder Sections



Figure 28
Secure Ladder Sections
with Spring Pins

STEP 11: Install the foot rest to the uprights using two (2) 3" bolts, eight (8) washers, and two (2) locknuts as shown in Figure 26. Make certain to place two (2) washers between the foot rest and upright, one (1) washer under the bolt head, and one (1) under the locknut as shown in Figure 26. Go back now and tighten the hardware to 50 inch pounds. Make certain all hardware is secure prior to attempting to use this product(s).

STEP 12: With the assembly still laying on the ground, install the ladder sections by pinning them together using the spring pins. Make certain the spring pins engage each ladder section as shown in Figure 27 and the spring clips are fully engaged as shown in Figure 28.



WARNING! The spring pins and spring clips must be positively engaged on each ladder sections. Failure to engage these spring pins as outlined will result in the ladder sections separating as you climb. Failure to follow these instructions may result in serious injury or death!

INSTALLING MILLENNIUM L-220-SL 18' DOUBLE LADDERSTAND



WARNING! Prior to attempting to use this or any other Millennium product(s) you must take a moment and become familiar with it's setup and installation at ground level. You must practice installing, setting-up and using this product(s) at ground-level prior to attempting to use it at heights above ground-level. Once you have become thoroughly knowledgeable and comfortable with this Millennium product(s) setup, installation and use at ground-level - you're now ready to use it at heights above ground-level. Failure to follow these instructions may result in serious injury or death!



WARNING! You must wear the factory provided full-body fall arrest harness included with this product at all times during use of this product. Failure to follow these instructions may result in serious injury or death!



WARNING! Never climb, install or use a treestand with a single safety belt or chest harness. These devices have been deemed unsafe for use in climbing apparatus applications and may endanger your personal safety. Use only the factory provided full-body fall arrest harness which meets or exceeds industry standards recognized by the TMA or an aftermarket full-body fall arrest harness system which meets or exceeds industry standards recognized by the TMA. Failure to follow these instructions may result in serious injury or death!



WARNING! DO NOT use this, or any other product(s) to climb utility poles, telephone poles, structural columns or any other man-made structures. Never use this or any other product(s) around power generation (transformers, generators, substations, etc.) and/or power transmission equipment (power lines). Failure to follow these instructions may result in serious injury or death!





WARNING! Do not use this or any other product(s) if you have a history of heart problems, back problems, impaired vision, equilibrium problems, high blood pressure or any other physical impairment that may limit your ability to use and/or operate this product(s) in the safe manner outlined in this Instruction Manual. Additionally, do not use this or any other product(s) if you are currently taking any medication and/or substance, including alcohol, that may limit your ability to use this product(s) as outlined and described in this Instruction Manual. Failure to follow these instructions may result in serious injury or death!

 **WARNING!** Do not attempt to use this or any other product(s) when thunderstorms are threatening and/or present within five (5) miles. Do not attempt to use this or any other product(s) when any other adverse weather condition presents itself. These include weather conditions which have the potential for producing winds, lightning, rain, snow, sleet and/or any other atmospheric condition which may limit the user's ability to operate this product(s) in a safe manner as described in this Instruction Manual. Failure to follow these instructions may result in serious injury or death!

 **WARNING!** This product(s) is designed for adult use only! No one under the age of 16 shall attempt to use this or any other product(s) without direct adult supervision. Failure to follow these instructions may result in serious injury or death!

 **WARNING!** Do not attempt to use this and/or any other product(s) when ice, snow and/or freezing rain has deposited or formed on any portion of the tree you intend to climb. Failure to follow these instructions may result in serious injury or death!

 **WARNING!** Never attempt to either climb up or climb down with a weapon in your possession. ALWAYS unload your weapon and pull it up to hunting height using a tether or pull-up rope. ALWAYS lower your unloaded weapon down to the ground prior to attempting to climb down. Failure to follow these instructions may result in serious injury or death!

 **WARNING!** Never attempt to hunt from an unlevel treestand. Additionally, never attempt to level your treestand at heights above the ground. If you find that your treestand is unlevel, canted, angled awkwardly upward or downward, or in any configuration other than level, immediately climb down to ground-level and readjust your treestand as necessary to alleviate this awkward angle. Failure to follow these instructions may result in serious injury or death!

 **WARNING!** Thoroughly inspect this or any other product(s) prior to each use for signs of wear, rot, corrosion, cracks, deterioration and/or any other type of defect. Protect this product from extended exposure to direct sunlight, excessive heat or freezing temperatures. Do not use this or any other product(s) if it shows evidence of wear, rot, corrosion, cracks, deterioration and/or any other type of defect. Failure to follow these instructions may result in serious injury or death!

We are very serious about your personal safety. A full-body fall arrest harness has been included with this product for your use. A full-body fall arrest harness system which meets or exceeds industry standards recognized by the TMA and designed to keep you from experiencing a fall.

Read the full-body fall arrest harness section (pages 8-14) carefully and follow all of the instructions! Your full-body fall arrest harness and its components (i.e., lanyard/tether, tree belt, climbing belt, Suspension Relief Device) is designed for a maximum capacity (user and equipment) of 300 pounds (136 kg). Additionally, your full-body fall arrest harness (and its components) must be replaced after three (3) years of service. Please contact Millennium for full-body fall arrest harness replacement procedures should you experience a fall or shall it exceed the three (3) year service period.

 **WARNING!** Prior to attempting to use this or any other product(s) you must take a moment and become familiar with its assembly, setup and installation. You must practice installing, setting-up and using this product(s) at ground-level prior to attempting to use it at heights above ground-level. Once you have become thoroughly knowledgeable and comfortable with this product(s) setup, installation and use at ground-level, you are now ready to use it at heights above ground-level. Failure to follow these instructions may result in serious injury or death!

 **WARNING!** These ladderstands were designed to be used on trees with a **MINIMUM DIAMETER OF 12" INCHES** at treestand installation height (i.e., seating platform height) and a **MAXIMUM diameter of 22" (56cm)**. **DO NOT** attempt to install on trees with smaller diameters. Failure to follow this warning may result in serious injury or death!

 **WARNING!** Never install, set-up, or climb to your ladderstand with a weapon. Use a pull up rope to carefully raise your unloaded weapon after full-body fall arrest harness is secure and you are set in the stand. Failure to follow these instructions may result in serious injury or death!

 **WARNING!** You must have at least three (3) adults to install and/or remove this ladder treestand. Failure to follow these instructions may result in serious injury or death!

 **WARNING!** **STOP NOW!!!!** Make sure that you are wearing your full-body fall arrest harness. Failure to follow these instructions may result in serious injury or death!

STEP 1: Select a straight, healthy tree, one devoid of branches, vines or other obstructions which may encumber your ability to climb safely. The installation tree must have a minimum diameter of 12" (30cm) at treestand installation height (i.e., seat height) or a maximum treestand installation diameter of 22" (56cm).

 **WARNING!** These Millennium product(s) were designed for installation on trees with a minimum diameter of 12" (30cm) at treestand installation height (i.e., seat height) and a maximum treestand installation diameter of 22" (56cm). **DO NOT** use your Millennium product(s) on trees with trunk diameters that do not meet this minimum diameter requirement. Failure to follow these instructions may result in serious injury or death!

STEP 2: Locate the two (2) stabilizing straps as shown in Figure 15. **NOTE:** There is a sewn-in loop on one end. Slip the loop end around the ladder adapters as shown in Figure 27. **REPEAT** for both stabilizing straps as shown in Figure 27.

WARNING! You must check the ground under the treestand to make sure it is firm and level. Sloping ground or uneven surfaces (e.g., one foot on a rock) can cause your ladder to tilt or shift off the tree as you climb. Failure to follow these instructions may result in serious injury or death!

WARNING! You must check the ground under the treestand to make sure it is firm and level. Sloping ground or uneven surfaces (e.g., one foot on a rock) can cause your ladder to tilt or shift off the tree as you climb. Failure to follow these instructions may result in serious injury or death!

WARNING! DO NOT use this, or any other Millennium product(s) to climb utility poles, telephone poles, structural columns or any other man-made structures. Never use this or any other Millennium product(s) around power generation (e.g., transformers, generators, substations, etc.) and/or power transmission equipment. Failure to follow these instructions will result in serious injury or death!

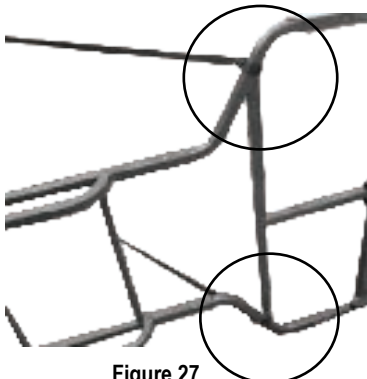

Figure 27
Secure the Stabilizing Straps to Ladder

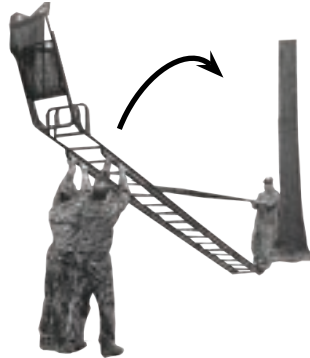

Figure 28
Walk Treestand Up
(Representative ladderstand shown)

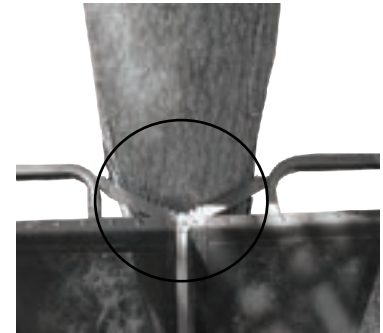

Figure 29
Tree Blade Centered

STEP 3: Clear the area on which you plan on placing the treestand. Remove all leaves, sticks, rocks and debris in a 5 to 6 foot perimeter. **NOTE:** The bottom section of the ladderstand will be placed here on the cleared, clean, level area.

STEP 4: Position the bottom ladder section in this cleared area (approximately 5' from the base of the tree trunk) and have one (1) adult stand on bottom rung of the bottom ladder section. The adult who is positioned on the bottom rung must control the stabilizing straps and the treestand as it is erected. The two (2) other adults shall gently walk the treestand assembly up and into position as shown in Figure 28. Once erect, make certain the tree blade is centered on the tree trunk as shown in Figure 29.

STEP 5: Make sure the ladder is not straight, but has about 15 degrees of angle as shown in Figure 30. This will put the bottom of ladder approximately 5 feet from the tree as shown in Figure 30. **NOTE:** The seat and standing platforms must be level for a proper and safe installation.

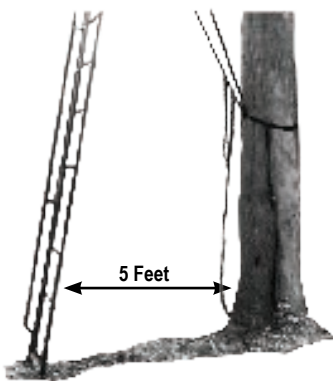

Figure 30
Treestand Set Correctly



Figure 31
Stabilizer Straps Installed

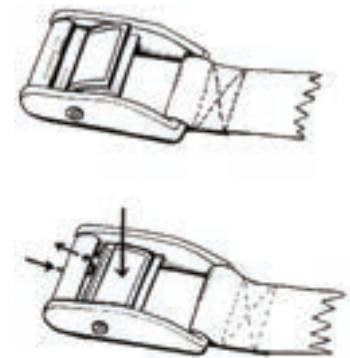

Figure 32
Thread Cam Buckle

STEP 6: Have one (1) adult place their weight on the bottom ladder rung. Doing so shall seat the ladder into the ground. **NOTE:** The bottom ladder rung must be flush with the ground for safe operation.

STEP 7: With the top stabilizer straps installed as previously outlined, slip the tree belt through the loops on the bottom of the stabilizing straps (as shown in Figure 31), thread the cam buckle as shown in Figure 32 and cinch the tree belt tight. Make certain the tree belt is not twisted and is very tight. With the tree belt installed and tightened, and while standing on the ground, pull the two (2) stabilizing straps tight. Do not over-tighten.

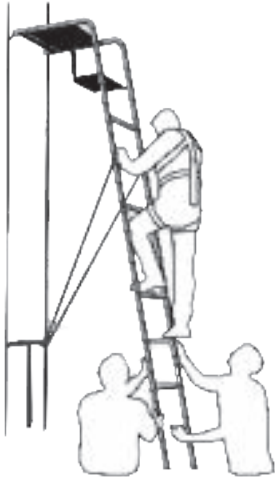

Figure 33
Two Adults to Help Steady Treestand Assembly (Representative ladder-stand shown)



WARNING! When climbing, always maintain three points of contact as you ascend (climb up) and while descending (climb down). Failure to maintain three points of contact puts the user at serious risk of bodily injury. Failure to follow these instructions will result in serious injury or death!



WARNING! As you approach the top of the ladder, attach your full-body fall arrest harness tether to the tree trunk as soon as possible. After your tether has been attached to the tree, attach the ratchet straps to secure the top of the stand to the tree. Do not sit or stand on the standing platform until the ratchet straps have been securely fastened. Failure to follow these instructions will result in serious injury or death!



Figure 34
Attach to Full-Body Fall Arrest Tether to Tree Trunk

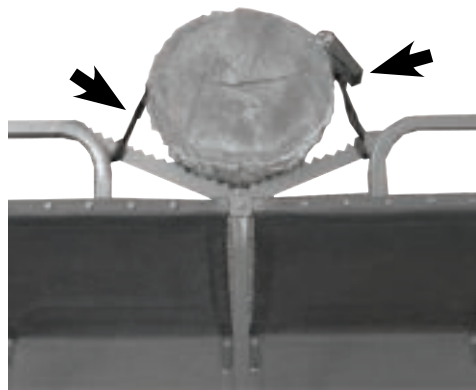

Figure 35
Ratchet Strap Attached to Tree Trunk (Cutaway tree view)

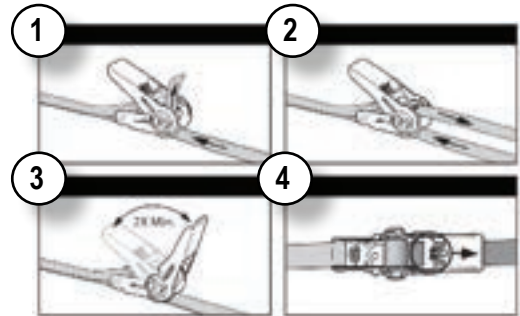

Figure 36
Ratchet Threading

REMOVING L-220-SL 21' DOUBLE LADDERSTAND



WARNING! STOP NOW!!!! Make sure that you are wearing your full-body fall arrest harness! Failure to follow these instructions may result in serious injury or death!



WARNING! When climbing, always maintain three points of contact as you ascend (climb up) and while descending (climb down). Failure to maintain three points of contact puts the user at serious risk of bodily injury. Failure to follow these instructions will result in serious injury or death!



WARNING! When climbing to remove the ratchet straps, it is important to lean forward when climbing to keep the stand centered and secure to the tree trunk. **DO NOT** lean backwards when climbing! Failure to follow these instructions will result in serious injury or death!



WARNING! As you approach the top of the ladder, attach your full-body fall arrest harness tether to the tree trunk as soon as possible. After your tether has been attached to the tree, remove the ratchet strap. Failure to follow these instructions will result in serious injury or death!

STEP 1: With the help of two (2) other adults (refer to Figure 35) at the base of the ladder stand holding it steady, climb to a height which allows you to safely attach your full-body fall arrest harness tether to the tree trunk as soon as possible. After your tether has been attached to the tree trunk, disconnect the ratchet strap which secures the tree blade.

STEP 2: Disconnect your tether and climb back down to the ground. Remove the stabilizer straps and disconnect the tree brace assembly. With the help of two (2) other adults, gently lower the treestand to the ground.

CARE AND MAINTENANCE/WARRANTY

Your new Millennium treestand is factory finished with a state-of-the-art powder coating that guarantees years of trouble-free service. It is recommended that you store your treestand out of direct sunlight and out of any other harsh environmental condition(s) that may adversely affect its performance.

IMPORTANT WARRANTY INFORMATION

Millennium Outdoors, LLC warrants this Millennium product against defect(s) in material and workmanship, under proper use and storage for the period of one (1) year from the date of purchase. Proof of purchase, plus, the return of your warranty application card to our home office, is required for any warranty claim. In the event this product is found to be defective within the warranty period, Millennium Outdoors, LLC only obligation and your exclusive remedy shall be replacement or repair of any defective parts at our discretion. To obtain warranty service, please contact Millennium Outdoors, LLC customer service at (601) 932-5832. Exclusions to this warranty include seat, paint, plastics, webbing and/or defects caused by operator misuse and/or abuse. Limitation to liability include the forgoing warranty is made in lieu of all other warranties, express or implied and Millennium Outdoors, LLC disclaims any implied warranty of merchantability and fitness. Millennium Outdoors, LLC shall not be liable for any damages direct, consequential or incidental arising out of the use or inability of this product.

WARRANTY APPLICATION CARD

I have read and understand the safety, assembly and operating instructions provided with my Millennium treestand. I fully understand the importance of using the full-body fall arrest safety harness which meets or exceeds industry standards recognized by the TMA, and realize that if I choose not to use the full-body fall arrest safety harness I am putting myself at an increased risk of injury should an accident occur while I am utilizing this Millennium product(s). I have read the warranty information and know that I can call Millennium at (601) 932-5832 with any questions or concerns that I may have about this or any other Millennium product(s). Mail to: Millennium Outdoors, LLC, 201 Fairmont Plaza, Pearl, MS 39208, (601) 932-5832.

NAME _____ PURCHASED WHERE _____

ADDRESS _____

CITY/STATE/ZIP _____

PURCHASE DATE _____

PRODUCT _____



PLEASE READ THIS MANUAL IN ITS ENTIRETY PRIOR TO USING THIS PRODUCT!

PLEASE READ THIS MANUAL IN ITS ENTIRETY PRIOR TO USING THIS PRODUCT!

PLEASE READ THIS MANUAL IN ITS ENTIRETY PRIOR TO USING THIS PRODUCT!



Millennium Outdoors, LLC 201 Fairmont Plaza Pearl, Mississippi 39208 (601) 932-5832
millenniumstands.com

PLEASE READ THIS MANUAL IN ITS ENTIRETY PRIOR TO USING THIS PRODUCT!